

1 Structure of an automated control system for an oil products warehouse

Object: Tank farm for storage of gasoline and diesel fuel, total volume $V=13300$ m³

Purpose: Equipping a tank farm with sensors and actuators, a control cabinet, as well as a workstation for observe the state of the equipment and operate actuators in real time.

The control cabinet - is an electrical panel with equipment for switching with external sensors and actuators. A PLC is installed in the control cabinet for receiving signals from external sensors and actuators via laid communication channels, and for issuing signals to actuators via laid communication channels. PLC is a microprocessor device that runs under the control of application software. Variables corresponding to incoming and outgoing communication channels are formed in the PLC memory to transmit data on the physical indicators of the process. The workstation has access to PLC variables.

Workstation - a personal computer with pre-installed special and application software for visualization of the " Tank farm ". On the workstation monitor screen, it is possible to remotely observe the status of sensors and to operate pumps, valves and other actuators.

The main stages of the work performed:

- For the construction of a new pumping station and the replacement of pumps, the installation of equipment for loading tankers, the replacement of the power supply and automation system, design and technical documentation was developed.
- For the installation of sensors (level sensors on tanks, sensors for monitoring the condition of pumps) and actuators (pumps, valves and taps with an electric drive), technical documentation was developed.
- Development of technical documentation for the assembly of the Control Cabinet with PLC S7-300 Siemens. Development of electrical circuits for connecting sensors and actuators to the control cabinet and for equipment communications inside the control cabinet.

- Creating of application software (PPO) in the STEP 7 environment for loading into the S7-300 Siemens PLC. Creating of application software (project for visualization and control of the Tank farm) in the WinCC Explorer environment for loading to a personal computer workstation.
- Installation of sensors and actuators at the Tank farm.
- Installation of equipment and PLC S7-300 Siemens inside the control cabinet, connecting it to sensors and actuators. Downloading the developed application software to the S7-300 Siemens PLC.
- Loading the visualization project into the personal computer of the Workstation, connecting the workstation to the PLC S7-300 Siemens (in the cabinet). Starting a visualization project in the WinCC Runtime environment. Commissioning, observing of the state of equipment and operating of actuators in real time.

Details of work performed:

Technological process at the facility - includes the transportation of fuel from railway transport to tanks using pumps. Storage of fuel in tanks. Transportation of fuel from tanks to road tanks using pumps and measuring devices.

A general view of the oil products warehouse is shown in fig. 1



The plan of the place for draining railway tanks, the location of tanks, pumps, pipelines and points for loading tank cars is shown in fig. 2

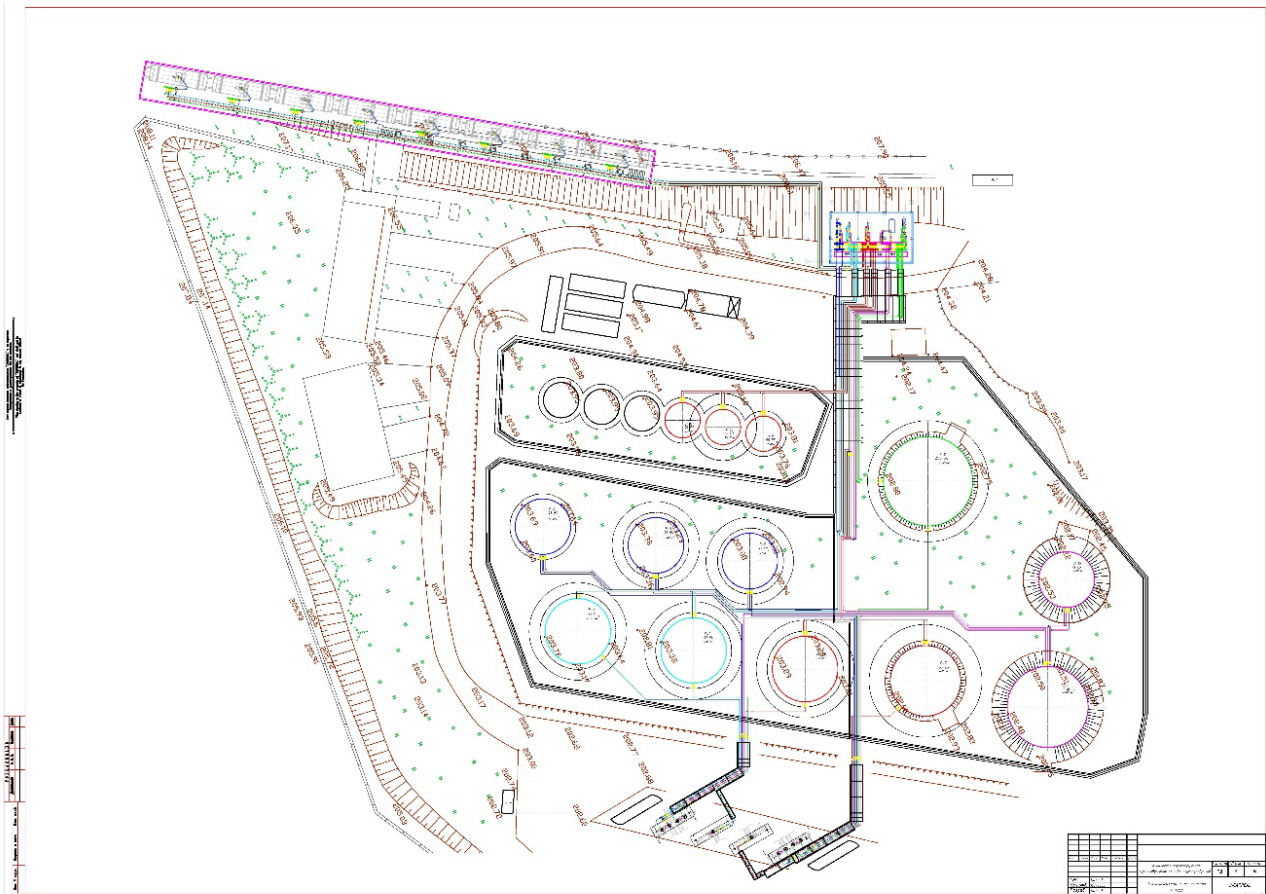

Technological equipment in the tank farm, including tanks, pumps, electric valves, pipelines, are installed in accordance with the technological scheme. Gasoline and diesel fuel (fuel) are contained and transported inside the process equipment. Fuel circulates in the equipment at given values of physical parameters (temperature, pressure, flow rate, level). The values of the physical parameters of the fuel are read and transmitted by sensors that are installed on the equipment and pipelines. The products are transported by pumps through pipelines, the flow rate of the liquid during transportation is controlled by electrically actuated valves. A flow diagram with indication of sensors was developed for a petroleum products warehouse and is shown in fig. 3.1, 3.2, 3.3

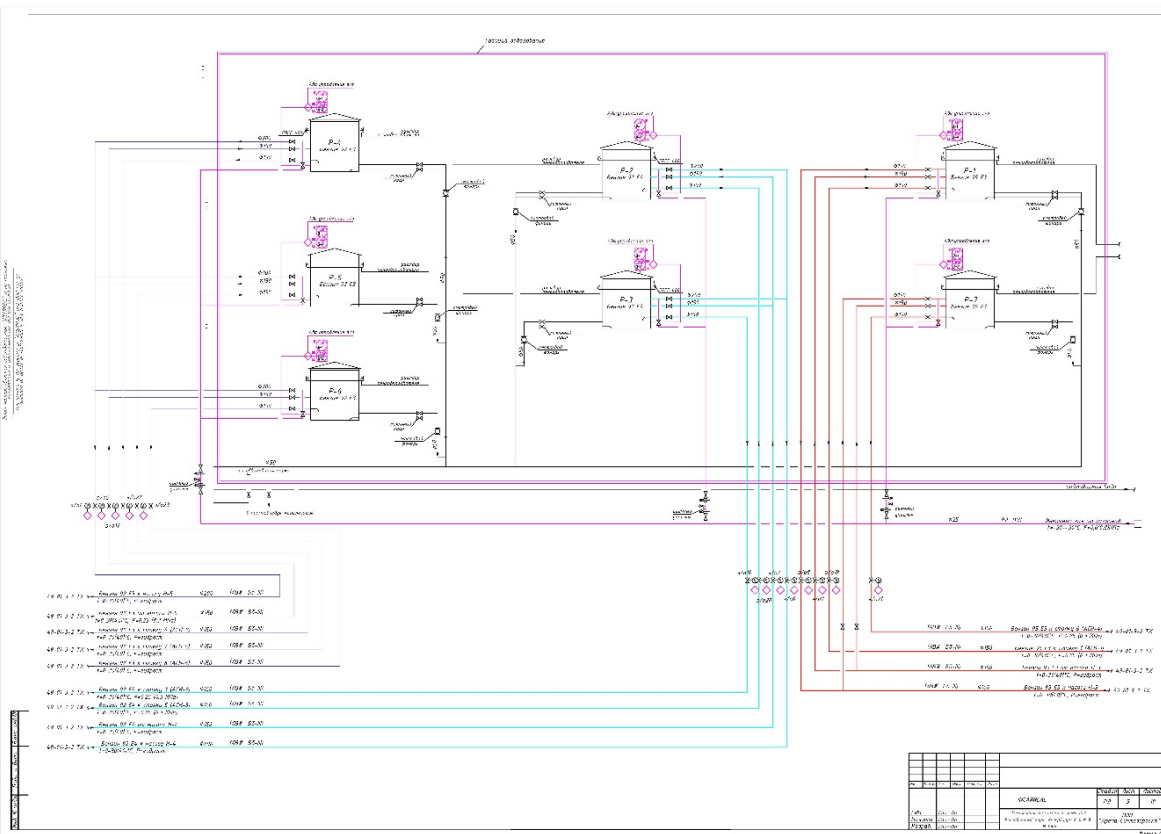
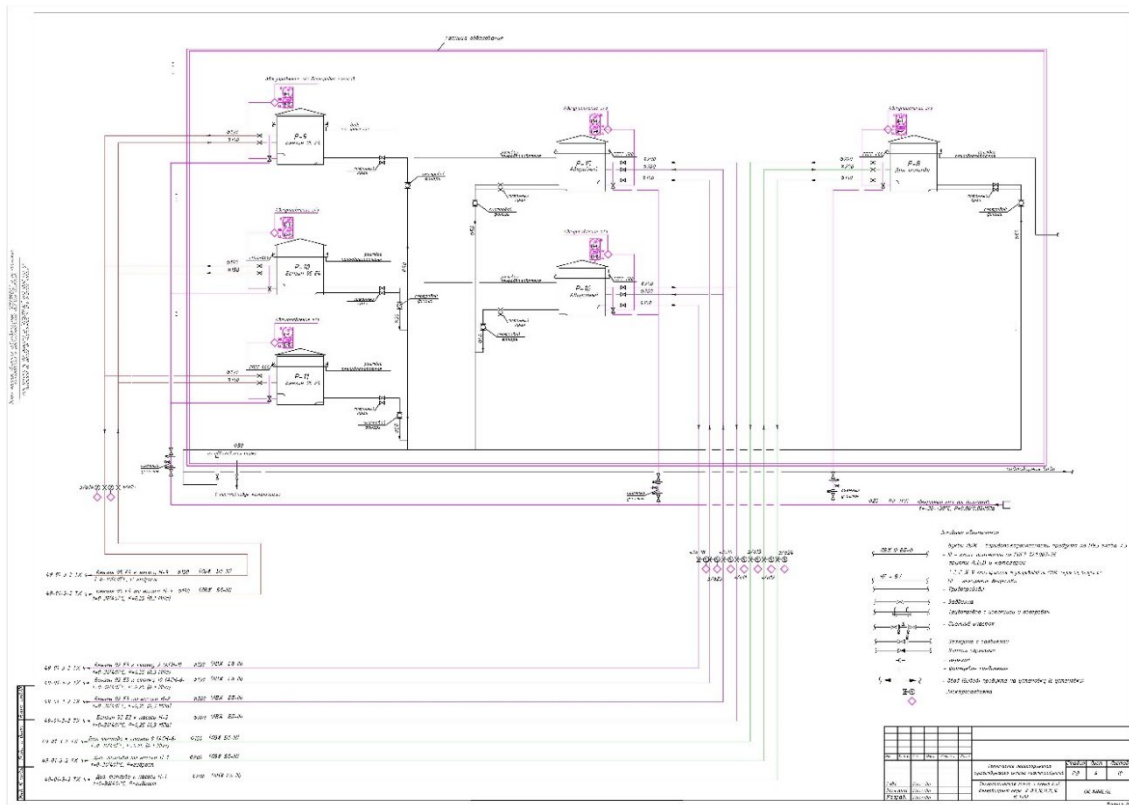

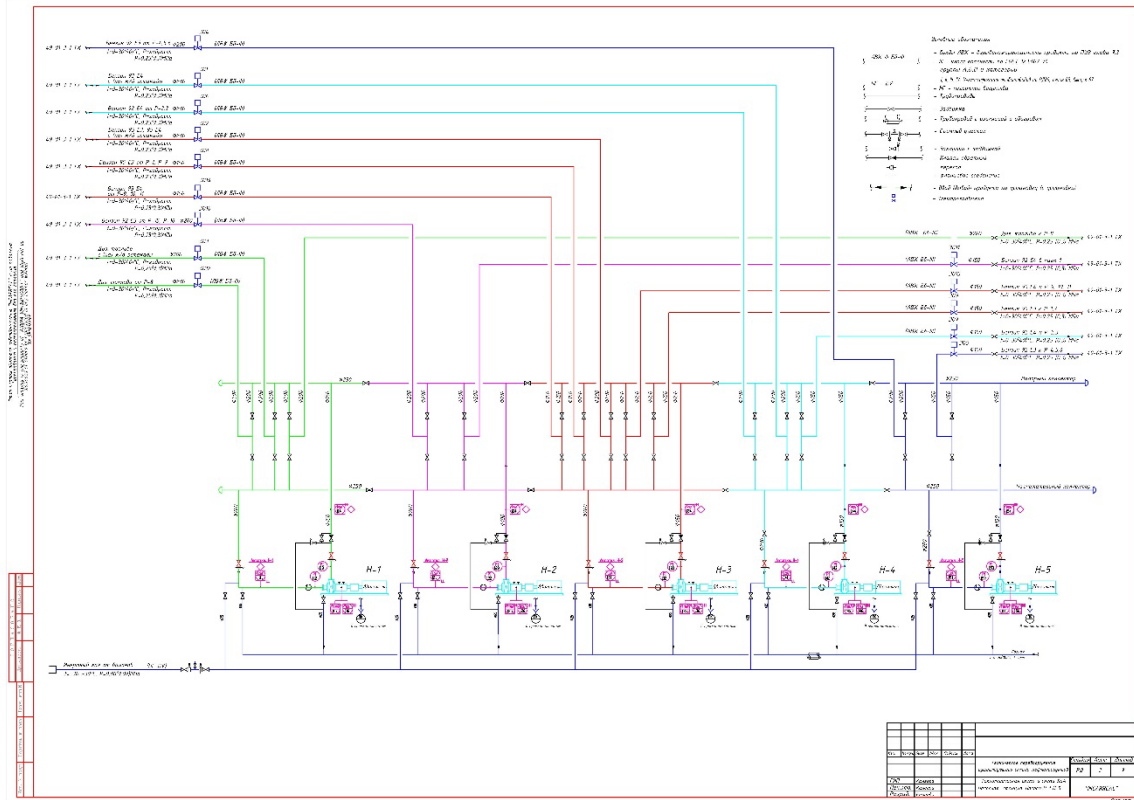

An automated process control system (APCS) has been created at the Tank farm to observe the physical indicators of the technological process and operate technological operations.

The automated process control system (APCS) performs:

- control (visualization) of the values of physical indicators of fuel inside the equipment;
- control of pumps and valves in order to keep the values of physical indicators in the required interval;
- control of pumps and valves in an emergency;
- control of pumps and valves by the operator, who monitors the values of physical indicators.

The block diagram of the Automated Process Control System (APCS) is shown in the figure below.

— - Сеть Ethernet
— - 4-20мА, 24В, 220В

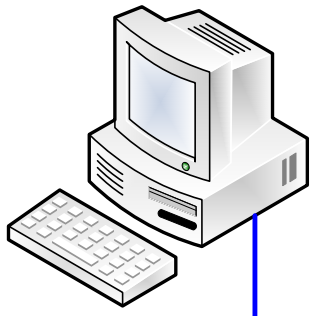

АРМ оператора

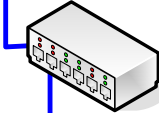

Коммутатор Ethernet



ПЛК S7-300



Датчики и исполнительные механизмы

The automated process control system is divided into three levels. For Tank farm, a block diagram of automation has been developed, see Fig. 4

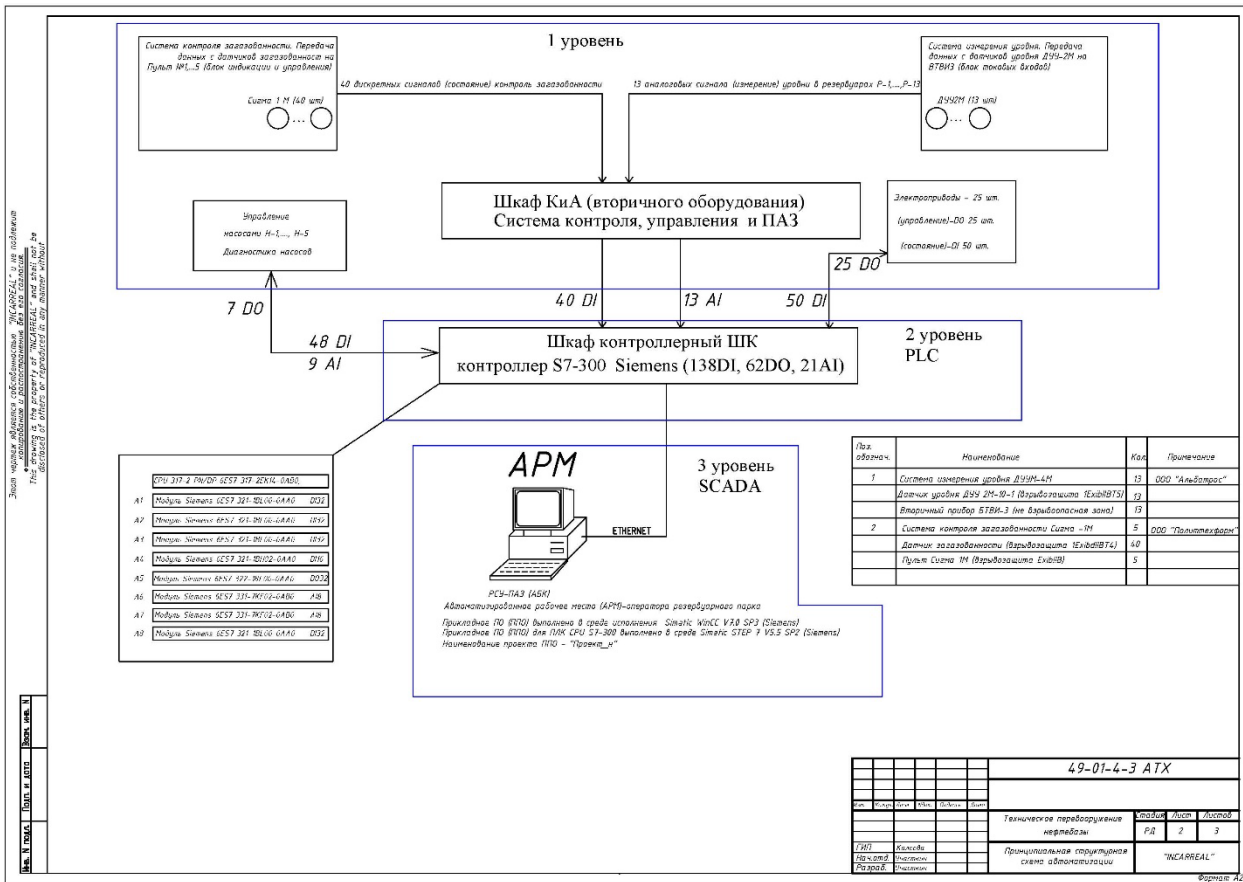

Level 1 - the lower level of automation - the level of instrumentation and actuators (sensors, pumps, valves). Functional automation schemes have been developed for Tank farm. In functional diagrams, sensors are shown for each piece of equipment and the communication channels of sensors with the PLC with their characteristics (discrete, analog, interface). Subsequently, in accordance with the functional diagram, the sensors were installed on the equipment and pipelines of the Tank farm. After installation, the sensors were connected to the cable control cabinet. Functional diagrams for the Tank farm can be seen in fig. 5.1, fig. 5.2,

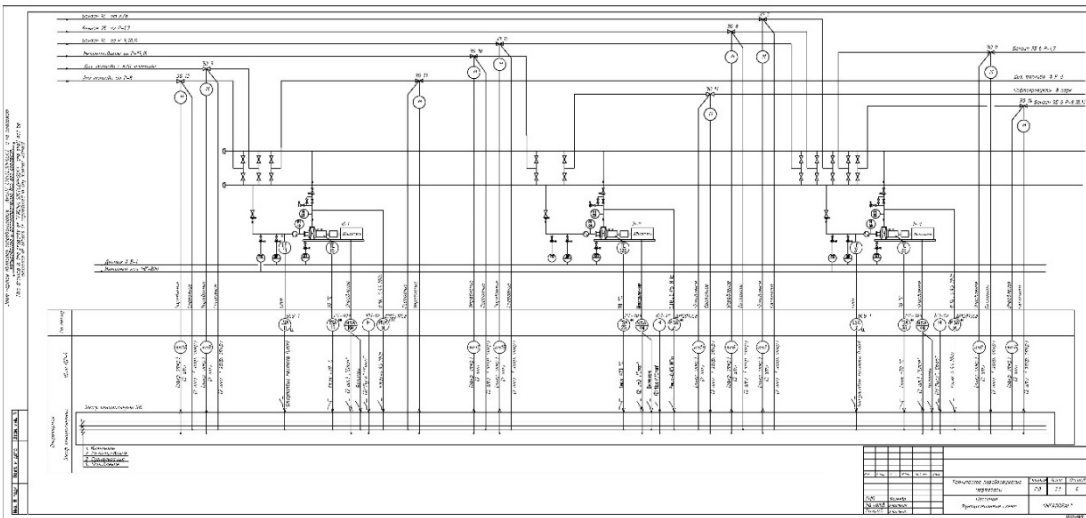
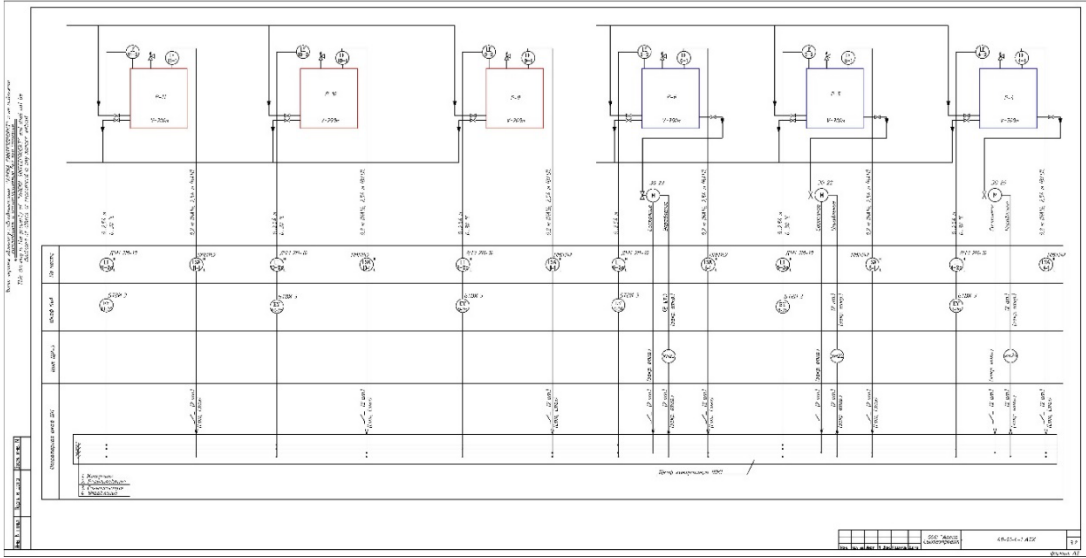

Level 2 - basic level of automation (controller level - SIMATIC S7-300). The composition of the second level 2 is a control cabinet with PLC S7-300 Siemens. The technical documentation for the control cabinet assembly, including wiring diagrams for connecting the equipment inside the cabinet, was developed for a Tank farm. Subsequently, the control cabinet was completed and installed on the Tank farm. The PLC control cabinet was connected to sensors, pumps and valves via previously designed communication channels. For process control, application software (APS) has been developed in the Simatic STEP 7 environment for downloading to the PLC. The composition of the control cabinet and its appearance is shown in fig. 6.1, fig. 6.2

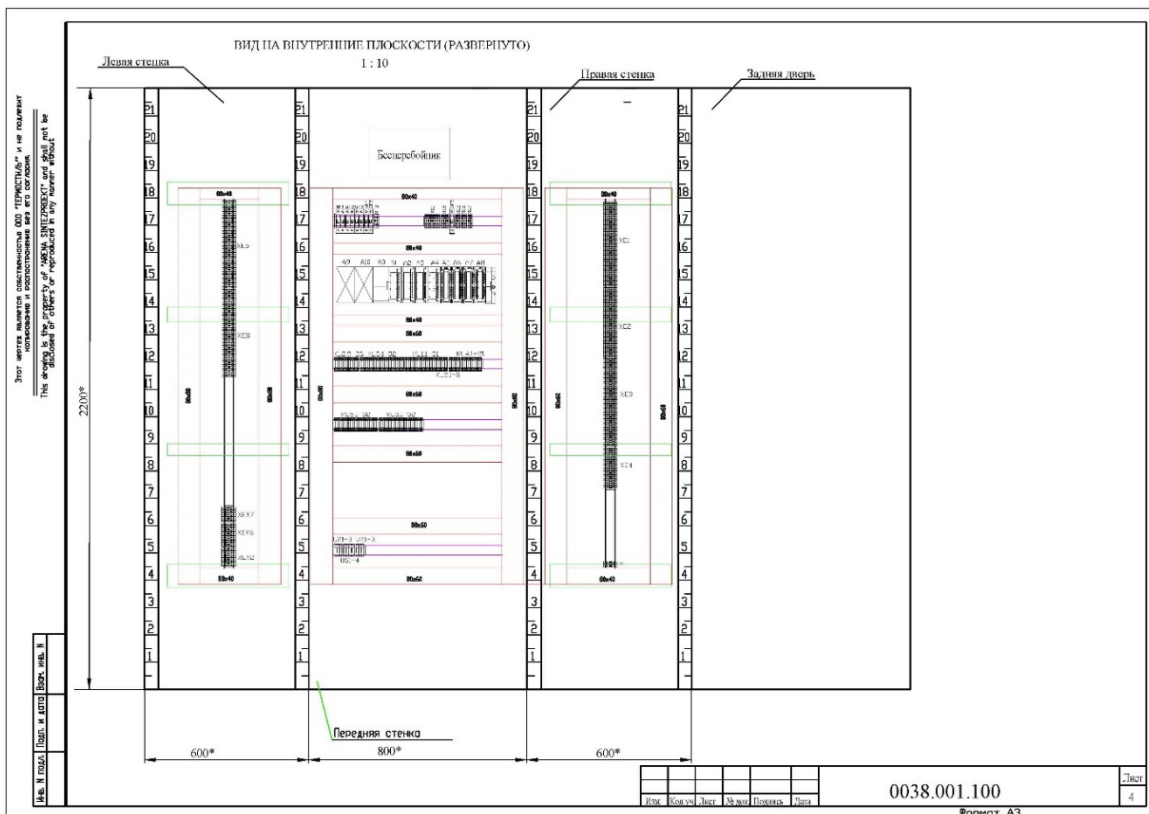

Level 3 – the upper level of automation (workstation – operator workstation). The composition of the 3rd level includes an automated workplace of the operator - a PC workstation (personal computer) (Human Machine Interface WinCC).

Special software - WinCC Siemens was downloaded to the personal computer of the workstation. It has two modules, the WinCC Explorer development environment and the WinCC Runtime runtime environment.

Application software (project for visualization and control of the Tank farm) was developed in the WinCC Explorer environment for Tank farm. The project contains a mnemonic diagram of a Tank farm, which is similar to the technological scheme of a Tank farm. Windows with physical indicators of the process (tags) are linked to the equipment and pipelines of the mnemonic diagram.

After development, the visualization project is run on the workstation in the WinCC Runtime environment. Communication is established between the personal computer of the workstation and the PLC (inside the control cabinet). Application program - visualization and control project accesses the PLC memory and identifies variables of physical quantities. Values of variable physical quantities of the PLC are assigned to the generated tags of the visualization project in real time. The mnemonic diagram of a workstation for a Tank farm is shown in fig. 7

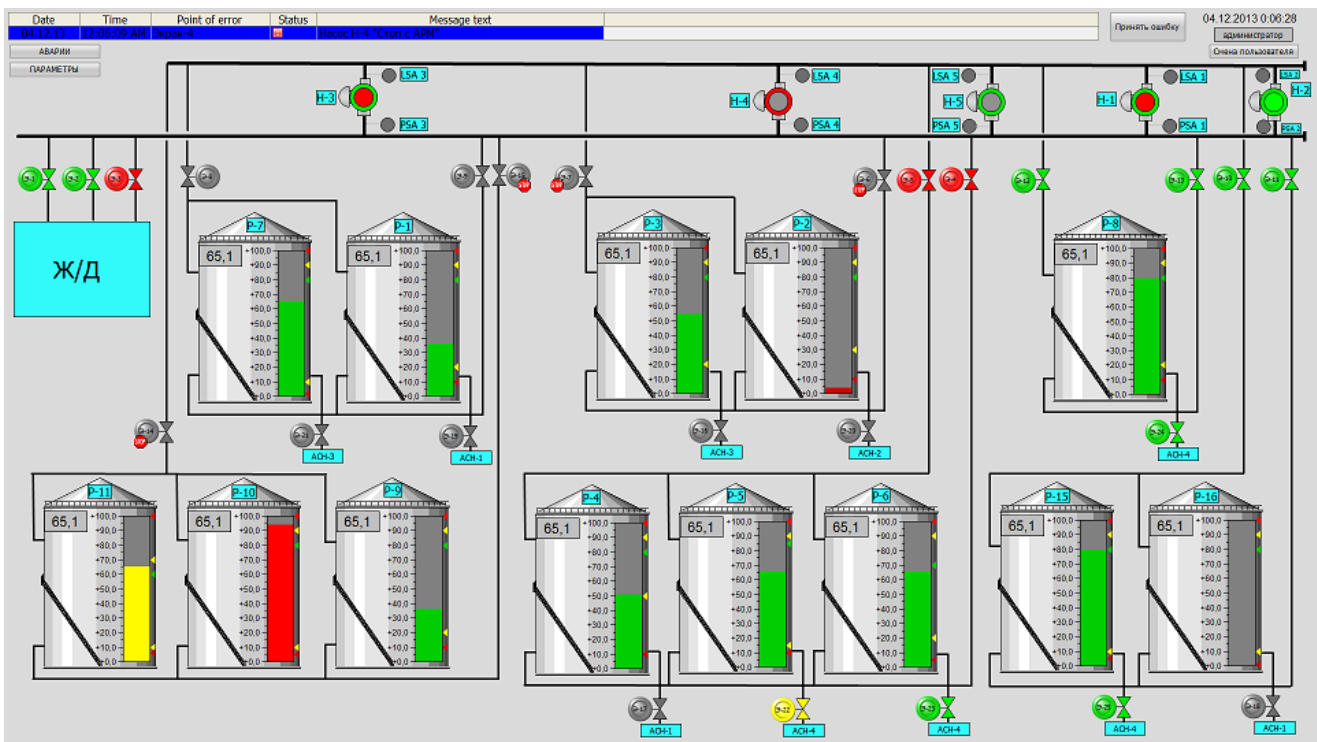

At the 1st level of automation, the following tasks are solved:

- obtaining information about the technological process and the operation of the equipment, which is the input for the 2nd level;
- control of actuators according to specified algorithms by control signals received from outputs of the 2nd level.

At the 2nd level of automation, the following tasks are solved:

- collection and processing of information coming from control and measuring devices of the 1st level;
- regulation of the technological process by supplying control signals to the actuators of the 1st level;
- inclusion of blocking of actuating mechanisms in case of technological parameters going beyond the permissible limits;
- alarm message generation;
- data exchange with 3rd level of automation.

At the 3rd level, the following tasks are solved:

- data collection and archiving;
- display on the monitor screen in a form convenient for the operator of operational data;
- display on the monitor screen in a form convenient for the operator of archived data;
- setting the settings and operating modes of the process control system for individual nodes of process equipment.